



**WINDSOR**  
WINDOWS & DOORS

# NEXT DIMENSION

Vinyl Windows & Doors





# Table of Contents

<b>The Versatility of Vinyl</b> .....	<b>4</b>
<b>The Next Dimension Difference</b> .....	<b>7</b>
<b>Signature Casement &amp; Awning</b> .....	<b>8</b>
<b>Signature Direct Set &amp; Radius</b> .....	<b>9</b>
<b>Classic Single Hung</b> .....	<b>10</b>
<b>Classic Slider</b> .....	<b>11</b>
<b>Classic Double Hung</b> .....	<b>12</b>
<b>Classic Direct Set &amp; Radius</b> .....	<b>13</b>
<b>Pro Single Hung</b> .....	<b>15</b>
<b>Pro Slider</b> .....	<b>16</b>
<b>Pro Direct Set &amp; Radius</b> .....	<b>17</b>
<b>Next Dimension Sliding Patio Doors</b> .....	<b>18</b>
<b>Our Quality is in the Details</b> .....	<b>19</b>
<b>Options &amp; Accessories</b> .....	<b>20-25</b>
<b>Size Specifications &amp; Technical Drawings</b> .....	<b>26-53</b>

# Imagine a Solution for Any Situation

**Windsor Windows & Doors can help bring your vision to life.** Our windows and doors open up a home to the light, air and beauty of the outside world. But it's the inspired designs and lasting performance of Windsor products that open up a world of possibilities for architects and builders.

Windsor has been developing unique home construction solutions for more than 70 years. We're dedicated to bringing you the highest quality products on the market, all for the best value.

Choose from a wide selection of products for new construction, remodeling or light commercial applications. Windsor's windows and doors allow you to get creative with your next project, without sacrificing quality or stretching your budget.

**Your Vision...Our Passion**



FEATURED ABOVE // NEXT DIMENSION SIGNATURE PICTURE WINDOWS. Ankeny, Iowa.

# The Versatility of Vinyl

Convenience meets dependability with Next Dimension windows and doors from Windsor. Advanced vinyl technology ensures easy operation, superior energy efficiency, low maintenance and high performance. And, with several hardware and finish options available in our Signature, Classic and Pro lines, Next Dimension offers a vinyl solution for any application.

## State-of-the-Art Lisec® Glass Fabrication Equipment

Our highly-automated glass line requires no manual manipulation – dramatically reducing seal failures caused by human contact with the glass – while our robotic equipment provides an incredible level of accuracy for a fast and efficient material flow.

## Super Spacer® Technology

Super Spacer dual-seal moisture barrier technology provides one of the most thermally efficient spacers in the marketplace, meeting or exceeding ENERGY STAR® guidelines in all zones. All-foam Super Spacer reduces heat and cold conduction, which results in more comfortable living for homeowners and fewer callbacks for builders.

## Super Spacer®

Reverse dual-seal technology

(Airspace is not filled with argon in products with breathing tubes.)

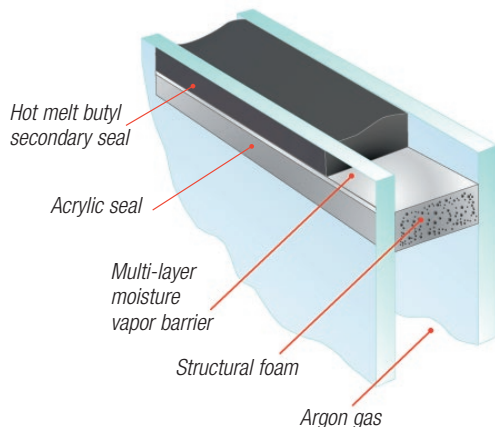

## Cardinal® LoE 366 Glass

Windsor products feature LoE 366 glass with a coating that alters the way glass transmits visible and invisible light. LoE 366 decreases heat loss in the winter and heat

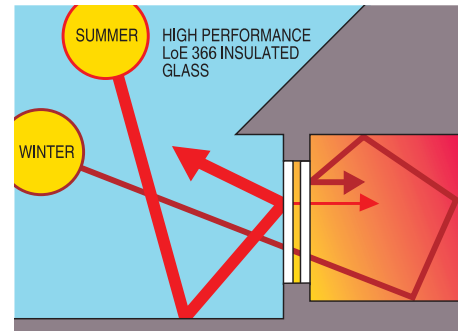

gain in the summer. Reduced ultraviolet light penetration also helps prevent your furniture, drapes and carpet from fading.

If you're searching for Dual Low-E and tempered insulated glass, look no further than Windsor. Combining Cardinal LoE 366 soft coating with Cardinal i89 LoE, the Dual Low-E glazing option creates clear, insulated glass with superior performance.

## ENERGY STAR® Partner

Windsor Windows & Doors is proud to be an ENERGY STAR partner. Look for the ENERGY STAR logo on our products, which means those models meet EPA guidelines for energy efficiency. Performance data is available on our website at [www.windsorwindows.com](http://www.windsorwindows.com).

## Warranty

Our Next Dimension products are backed by a Lifetime Limited Warranty; one of the most comprehensive warranty coverages offered in the industry. For more specific information, go to [www.windsorwindows.com](http://www.windsorwindows.com).





# The Next Dimension Difference

Commercially rated performance. Smooth, lasting operation. The advanced vinyl technology utilized in Next Dimension windows and doors means increased weather resistance and superior durability, giving you years of worry-free operation.

**[1] POSITIVE PRESSURE DRAINAGE SYSTEM** Excessive rain and condensation concerns are alleviated by our drainage system, which prevents build ups by directing water away toward the exterior.

**[2] NAIL FIN** Easier installation is achieved through the use of an extruded, rigid, pre-punched nail fin surrounding the perimeter of the frame. And, the integrated nail fin provides increased strength and resilience.

**[3] EXTERIOR AND INTERIOR COLOR OPTIONS** Next Dimension lets the true color shine through with vinyl that is guaranteed never to fade, peel or chip. Standard extrusion colors include white and clay, while optional exterior finishes are available in white, ivory, tan, bronze, cinnamon, hunter green and black. Painted interior optional finish available in black. And, our white finish color never varies; white is truly white. Note: White Signature products with black exterior will be laminated. Laminated exterior starting summer 2023.

**[4] MULTI-CHAMBERED EXTRUSION** Thick, multi-chambered extrusions add strength and decrease air infiltration while allowing for seasonal expansion and contraction.

**[5] TESTING TO MEET SIX INDUSTRY STANDARDS** We test all Next Dimension products to the strict standards set by AAMA/WDMA/CSA/101/I.S.2/A440-11 for air, water and structural performance. Our vinyl extrusions are AAMA certified on an ongoing basis.

**[6] EIGHT ADDITIONAL QUALITY TESTS** We take quality control even further by putting the material through eight additional tests for durability and quality construction.

**[7] REINFORCEMENT BARS FOR ADDED STRENGTH** For added safety in certain large window applications, we use galvanized steel or aluminum reinforcement bars to bolster strength.



[2]

[3]

#### Standard Vinyl Colors



#### Vinyl Exterior Colors



#### Painted Vinyl Interior Colors

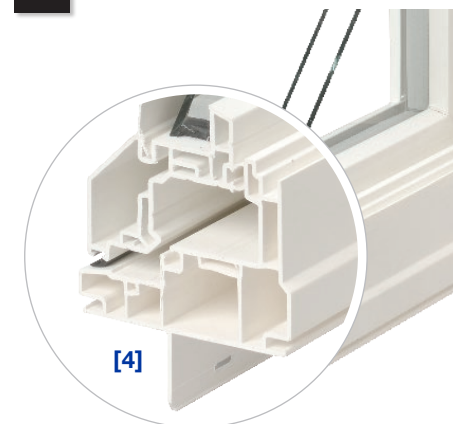

[4]

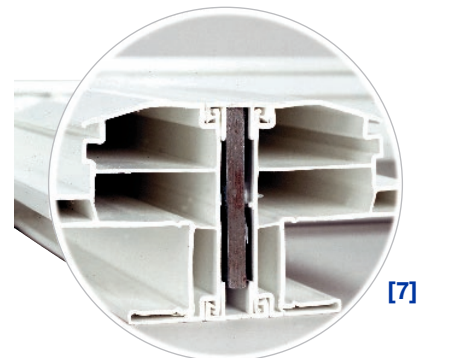

[7]



NEXT DIMENSION SIGNATURE CASEMENT AND PICTURE WINDOWS. Ankeny, Iowa.



Multi-point locking system

## Signature

# Casement & Awning

**Next Dimension Signature casement windows are designed with easy operation in mind, allowing you to bring the outdoors inside.** With a multi-point locking system, featuring a number of lock points along the sash to create a weathertight seal, our casement windows offer superior energy efficiency. Performance is made simple

and fluid through a single lock lever located low on the casement, meaning every window is easy to operate, regardless of where it's placed.

Let the world in with Next Dimension Signature.





NEXT DIMENSION SIGNATURE DIRECT SET AND CASEMENT WINDOWS. Norwalk, Iowa.

## Signature

# Direct Set & Radius

**Showcase your creative side.** Choose a modern or traditional look with Signature direct set and radius windows. Add a matched trapezoid above your casement windows. Finish off a picture window with quarter rounds.

Add in color and glass options and the choices and combinations are seemingly endless.



## Classic

# Single Hung

**Conventional beauty that performs as well as it looks.** With a long list of features and options to suit your aesthetic vision, combined with the durability and easy operation of vinyl, Next Dimension Classic single hung windows offer years of functional good looks.

Features include an integral weep system for a sleek look, block and tackle balances for effortless operation, integral lift/pull handle for easy access and optional simulated

divided lites to create the look of individual panes while maintaining the energy efficiency of a single pane of insulated glass.

Establish a new tradition of beauty with Next Dimension Classic single hung windows.



## Classic Slider

**Opening and closing your windows is now a thing of beauty with the Next Dimension Classic slider.**

Blending smooth gliding operation with traditional styling and the technological advantages of vinyl construction, Next Dimension Classic is sure to meet your performance and architectural needs.

A roller supported venting sash offers effortless operation, and simulated divided lites, pocketed sill, integral weep

system and other features lend traditional sitelines for a classic look. Additionally, a fusion-welded frame sash, air spaces in chambers and locking mechanism all contribute to enhanced energy efficiency.

When you're searching for a high-performance sliding window with traditional character, look no further than Next Dimension Classic.



## Classic

# Double Hung

**Convenience and durable performance in a traditionally styled package.** That's what you can expect from Next Dimension Classic double hung windows. Our Classic double hung windows make easy cleaning a breeze. Block and tackle balances, tilt sash and an integral lift/pull handle on the bottom rail allow hassle-free cleaning.

With convenience comes years of strength and energy efficiency. As an alternative to traditional nails or screws, we utilize a fusion welding process in the frame and sash corners to increase strength and leak-resistance. Additional energy saving and weatherproofing features include the Windsor Glazing System, thick, multi-chambered vinyl extrusions and a locking mechanism that creates a tighter seal at the vent and fixed sash.

Our double hung windows come with two frame options: a brickmould frame or a standard non-brickmould frame. A sloped sill, standard colors in white and clay, available simulated divided lite, multi-level profile and integral weep system give Next Dimension Classic double hung windows the traditional architectural sitelines certain to complement your design style.



## Classic

# Direct Set & Radius

**Add a touch of personality to your traditional style with Next Dimension Classic direct set and radius windows.** With availability in round, half-round, rectangle, trapezoid, triangle and other geometric shapes, our direct set and radius windows offer a modern flair to complement any design.

And, with a variety of inner grille configurations, colors and glass options, Classic direct set and radius windows let you choose a distinct look for your home.



NEXT DIMENSION PRO SINGLE HUNG AND PICTURE WINDOWS - Cedar Rapids, Iowa



## Pro Single Hung

**For the traditional look, year after year.** With numerous features and options, along with dependable use and the durable reputation of vinyl, Next Dimension Pro single hung windows are made to last, and look good doing it.

Features include an integral lift/pull handle for easy access and operation, block and tackle balances for smooth

performance and Windsor's exceptional lock and keeper lends a cleaner siteline while creating a tighter seal.

The stylish approach to longevity is yours with Next Dimension Pro single hung windows.



NEXT DIMENSION PRO SLIDING WINDOWS. Cedar Rapids, Iowa.

# Pro Slider

**Slide your way to style.** A sleek look and effortless opening and closing make the Next Dimension Pro slider a perfect fit for your home.

The fusion-welded frame and sash creates a strong, leak-proof seal, and the pocketed sill adds strength and performance. Additionally, with options available in horizontal or end vent configurations, you'll never run out of choices with Next Dimension Pro sliding windows.



Lock and keeper promotes better sitelines and creates a tighter seal between the vent and fixed sash for improved weather performance.

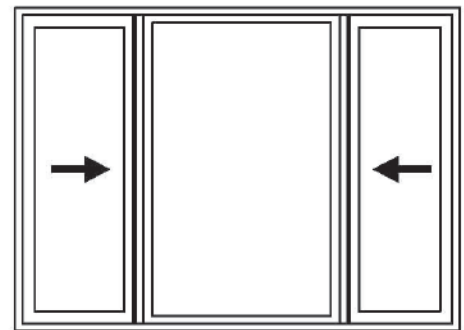
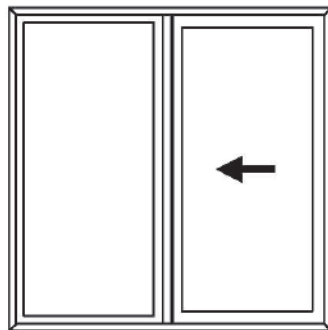
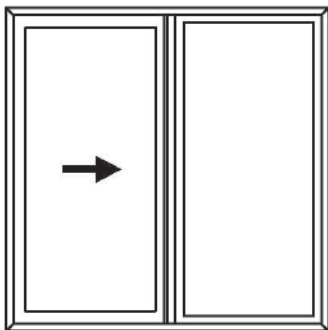



**Pro**

# Direct Set & Radius

**It's all about personality.** Your personality. Next Dimension Pro direct set and radius windows allow for that special touch of creativity that makes a home stand out.

Available with all of the features and benefits of the Pro Series, including leak-resistant construction and clean lines, our direct set and radius windows come in a variety of unique sizes and shapes. Giving your home a personal touch is easier than ever when you choose Next Dimension Pro.



FEATURED ABOVE // NEXT DIMENSION PRO DIRECT SET WINDOWS. Urbandale, Iowa.



NEXT DIMENSION SLIDING PATIO DOOR, Ankeny, Iowa.

## Next Dimension Sliding Patio Doors

**The door to beauty is wide open.** Next Dimension sliding patio doors are built to provide easy sliding, every time you open or close them.

Next Dimension sliding patio doors are designed to be easily installed for new construction and replacement alike. Versatility shines through with a range of accessories, glass options, colors and blinds between the glass, including the “D” shaped handle, which comes in five colors to add the final personal touch to your sliding patio door.



Building on the ease-of-use and long-lasting performance of all Next Dimension products, our sliding patio doors can be fitted with an optional blinds between the glass system. Featuring simple, no-cord operation safe for pets and children, lift and tilt functionality and effortless cleaning, our patio doors with blinds between the glass are designed to offer a no-hassle solution to let you control natural light and privacy in your home.

Plus, you'll enjoy all the long-lasting performance and beauty afforded by the Next Dimension line of vinyl products.

# Our Quality is in the Details

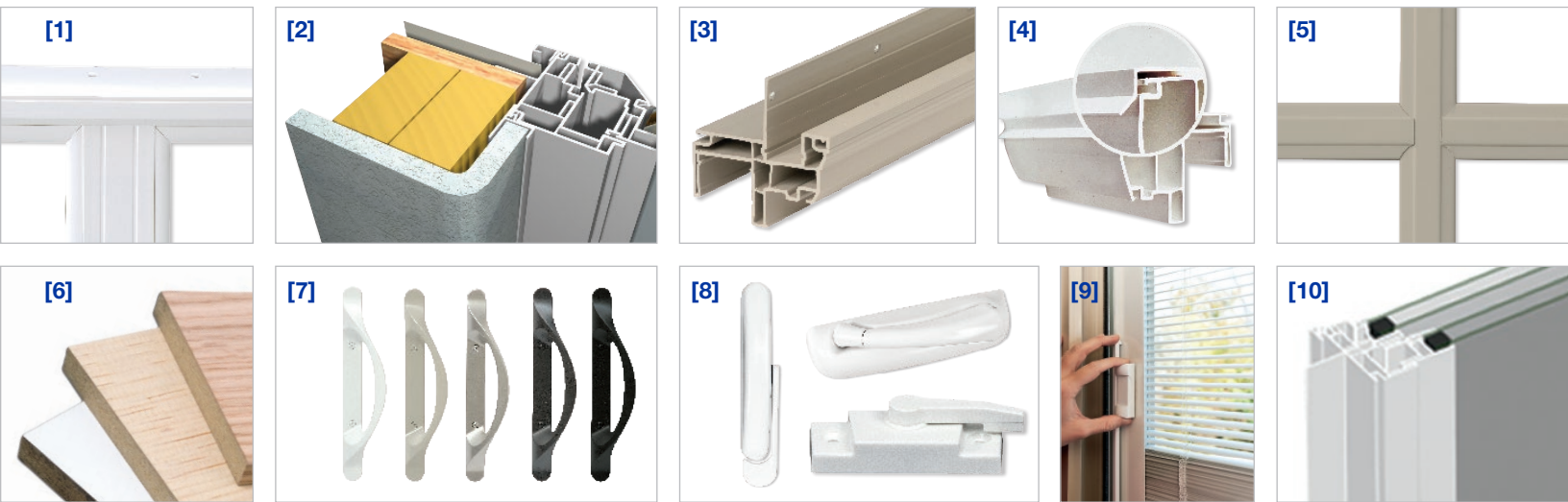

**[1] MULLION POST** Next Dimension Pro windows utilize an aluminum reinforced T-bar mullion post between two windows to provide an attractive appearance, added strength and to prevent air and water infiltration.

**[2] DRYWALL RETURN** This accessory provides a groove for drywall to slide into, providing a sleek, finished interior edge.

**[3] INTEGRAL J-CHANNEL (*Pro & Classic Only*)** Provides a smooth, finished edge for vinyl siding applications. Available on single hung, slider, picture and radius.

**[4] DRIP CAP** Just another detail we added to the top of the mull to ensure water stays out.

**[5] GRILLES** 3/4" profiled aluminum grilles are color matched to the unit and installed within the insulated glass airspace. This provides the look of authentic divided lite and allows for easy cleaning. 5/8" and 7/8" putty simulated divided lite grilles are available in Signature and Classic windows.

**[6] EXTENSION JAMBS** Extension jambs are available in veneer wrapped pine and oak for stained interiors or in white for painted interiors. These are available as a separate kit or applied.

**[7] SLIDING PATIO DOOR HARDWARE** Our patio door handles feature a versatile "D" shape in white, clay, satin nickel, faux bronze or black to coordinate with your door color.

**[8] WINDOW HARDWARE** The beauty of Next Dimension windows is carried right down to the sleek design of our hardware. They are available in clay, white or black to match the units.

**[9] BLINDS BETWEEN THE GLASS (*Patio Door Only*)** Control light and privacy with blinds between the glass. This no-cord, easy-to-clean option adds lift and tilt features, simple operation and long-lasting performance.

**[10] EASY-OUT™ SASH SYSTEM (*Pro Only*)** A feature unique to Next Dimension Pro models, the Easy-Out Sash System is designed for easy removal of the entire lower sash, making installation and replacement easier than ever. And, the Easy-Out Sash System's pocket design creates consistent pressure against the weatherstrip, meaning no loss in air and water performance.

# Options & Accessories

**Finishing touches to perfect your vision.** Windsor does more than just create durable, high-performance windows and doors. We pay attention to every detail and offer a wide array of options and finishes to match any décor. Flashy and eye-catching or simple and understated, our hardware, finishes, grille options, vinyl colors, glass options and grille patterns complete the perfect window and door package.

## STANDARD VINYL COLORS

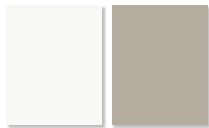

White Clay

## VINYL EXTERIOR COLORS

White vinyl interior is available with white, ivory, tan, bronze, cinnamon, hunter green or black exterior. Clay vinyl interior is available with bronze or black exterior.



White Ivory Tan Bronze Cinnamon Hunter Green Black\*

*\*Effective summer 2023: White Signature products with black exterior will be laminated and not painted*

## PAINTED VINYL INTERIOR COLORS



Black\*\*

*\*\*Only available with painted or laminated black exteriors*

## WINDOW HARDWARE

Hardware is available in white, clay or black.

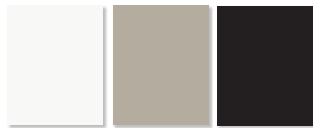

White Clay Black

### Classic Single Hung and Slider Lock



### Signature Casement and Awning Crank/Cover and Lock



Lock



Traditional Crank/Cover



Contemporary Crank/Cover

### Classic Double Hung Lock



### Pro Single Hung and Slider Lock



*(Black available on Slider only.)*

**GRILLES** All cellular PVC Windsor Divided Lite (WDL)<sup>1</sup> bars are hand-fitted to ensure a perfect fit.

\*Not available in Pro.

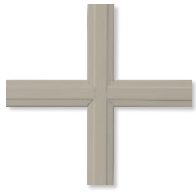

3/4" Profiled Inner Grille

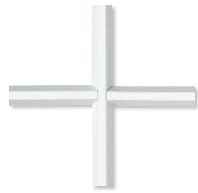

5/8" & 7/8" Putty Windsor Divided Lite (Exterior only) with Flat Inner Grille\*

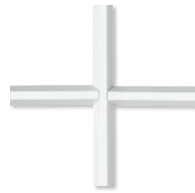

5/8" & 7/8" Putty Windsor Divided Lite\*



2" Simulated Check Rail

**GLASS** \*Special order item



LoE 366 (Standard)



Dual Low-E



LoE 180



LoE 240



LoE 272



Clear



Gray Tint



Bronze Tint

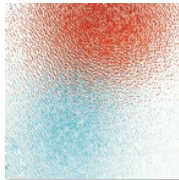

Obscure



Satin Etch

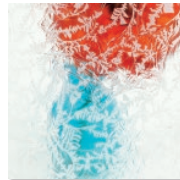

Glue Chip\*



Rain\*

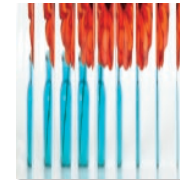

Reed\*

**SCREENS**

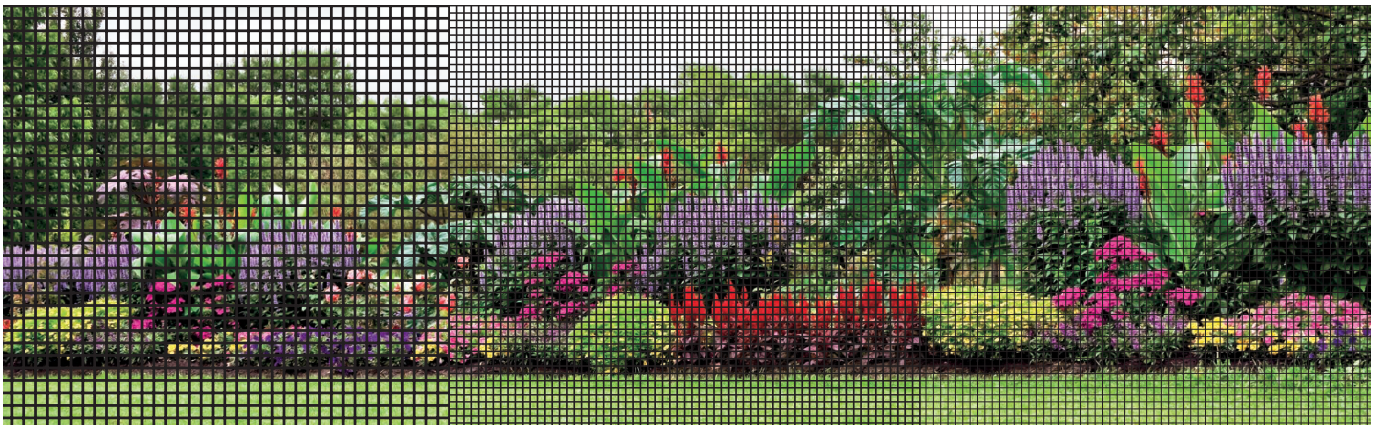

Conventional Screen Mesh

BetterVue® (Standard)

UltraVue®

<sup>1</sup>WDL bars are available in Signature casement, awning, direct set and radius windows.

**NOTE:** Printing limitations prevent exact color/finish representation. See your Windsor distributor for actual samples.



NEXT DIMENSION PRO SINGLE HUNG AND PICTURE WINDOWS. Cedar Rapids, Iowa.

## DIRECT SET AND RADIUS OPTIONS

### Radius Special Shapes



Round



Half Round



Quarter Round



Seg-top Quarter



Seg-top



Extended Quarter Round



Round Top



Ellipse



Eyebrow

### Direct Set Special Shapes



Rectangle



Flat-top Trapezoid

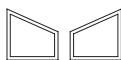

Trapezoid



Right Triangle



Triangle



Parallelogram



Octagon



Hexagon



Pentoid



Flat-top Pentoid

### Radius Inner Grille Patterns

Note: Before selecting a special grille pattern, confirm alignment with units below.

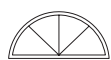

Pattern 1  
3-spoke  
Standard

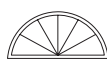

Pattern 2  
5-spoke  
Standard



Pattern 3  
Single Radius  
Starburst  
42" HR & up

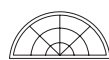

Pattern 4  
Double Radius  
Starburst  
60" HR & up



Pattern 5  
Single Radius  
Sunburst  
42" HR & up

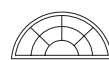

Pattern 6  
Double Radius  
Sunburst  
60" HR & up



1-spoke  
Quarter Round



2-spoke  
Quarter Round



3-spoke  
Ellipse

**GRILLE PATTERNS** Some grille patterns are not available in all configurations and products.

**Single and Double Hung Grille Patterns**

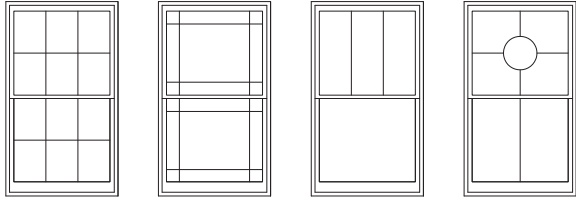

Colonial      Prairie      Plaza      Custom Pattern (Example)

**Casement and Awning Grille Patterns**

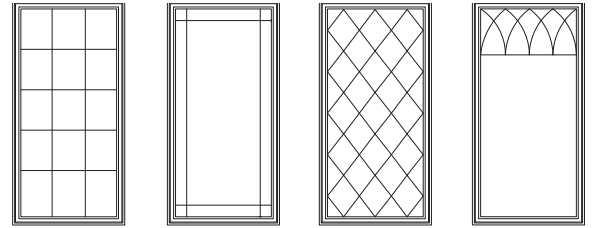

Colonial      Prairie      Diamond      Gothic

**Patio Door Grille Patterns**

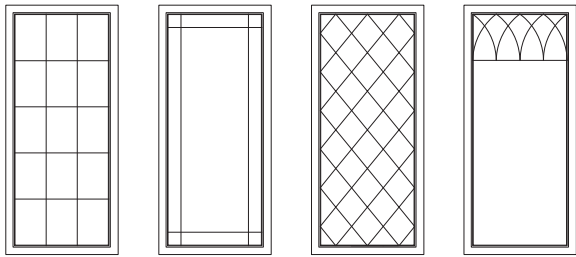

Colonial      Prairie      Diamond      Gothic

**Casement and Awning Grille Patterns**

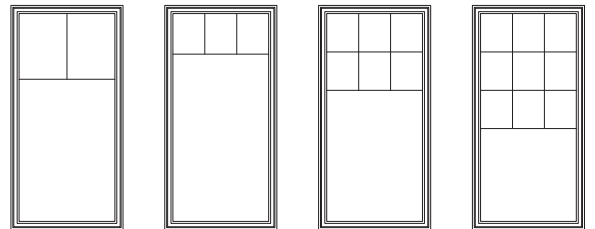

Custom Plaza      Single Plaza      Double Plaza      Triple Plaza

**Patio Door Grille Patterns**

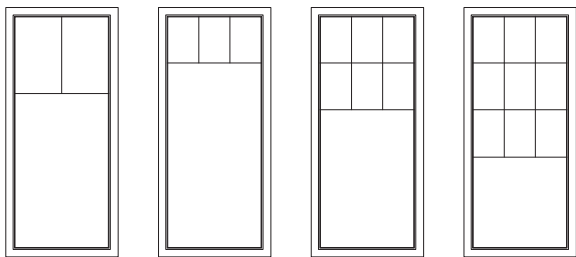

Custom Plaza      Single Plaza      Double Plaza      Triple Plaza

**Casement and Awning Grille Patterns**

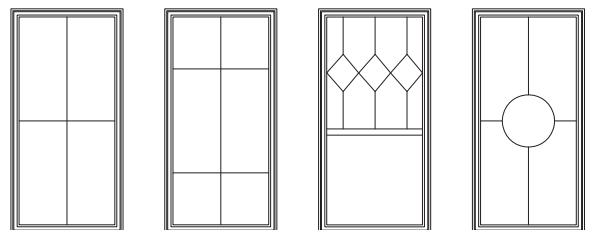

Specified Equal Lite (2x2 shown)      Custom Pattern (Example)      Custom Pattern (Example)      Custom Pattern (Example)

**Patio Door Grille Patterns**

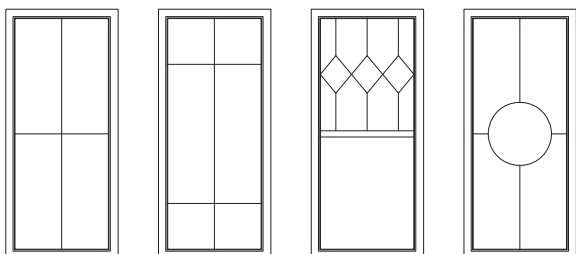

Specified Equal Lite (2x2 shown)      Custom Pattern (Example)      Custom Pattern (Example)      Custom Pattern (Example)



## SLIDING PATIO DOOR HANDLE AND FINISHES

Finishes are the same for both interior and exterior handles.



\*Only available with painted/laminated exteriors

## SLIDING PATIO DOOR BLINDS BETWEEN THE GLASS

All vinyl sliding patio doors are handed from the exterior. The images shown below are viewed from the interior looking out to show proper location of blind/tilt and raise/lower mechanism.

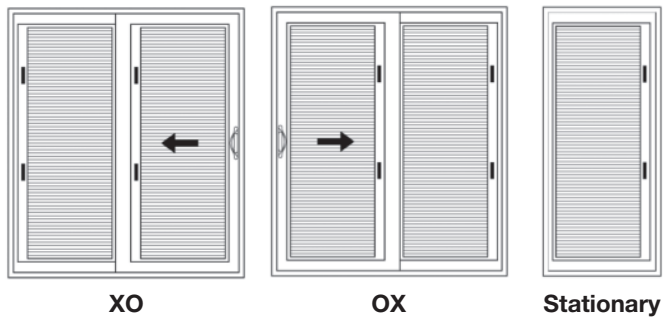



**WINDOW TRIM** Custom-fitted wood trim is available in Clear Select Pine.

### Interior Trim



WM 327 • 2-1/4"



WM 356 • 2-1/4"



WM 366 • 2-1/4"



WM 351 • 2-1/2"



WM 361 • 2-1/2"



WM 445 • 3-1/4"



WM 444 • 3-1/2"



RB 03 • 3-1/2"



WM 473 • 2-1/4"



WM 433 • 3-1/4"



WM 412 • 3-1/2"

### Stool and Apron

Available in double or single hung windows



WM 1021 • 5-1/4"



B 200 • 11/16" x 2-1/2"

### Rosettes



Rosette • 2-3/4"



Rosette • 3-3/4"

# Next Dimension Signature

## Casement, Awning & Picture

Rough Opp Frame	1-6	2-0	2-6	3-0	3-6	4-0	4-6	5-0	6-0	7-0	8-0
	1-5 1/2	1-11 1/2	2-5 1/2	2-11 1/2	3-5 1/2	3-11 1/2	4-5 1/2	4-11 1/2	5-11 1/2	6-11 1/2	7-11 1/2
2-0 1-11 1/2	1824	2424	3024	3624	4224	4824	5424	6024	7224	8424	9624
2-6 2-5 1/2	1830	2430	3030	3630	4230	4830	5430	6030	7230	8430	9630
3-0 2-11 1/2	1836	2436	3036	3636	4236	4836	5436	6036	7236	8436	9636
3-6 3-5 1/2	1842	2442	3042	3642	4242	4842	5442	6042	7242	8442	9642
4-0 3-11 1/2	1848	2448	3048*	3648	4248	4848	5448	6048	7248	8448	9648
4-6 4-5 1/2	1854	2454	3054*	3654	4254	4854	5454	6054	7254	8454	9654
5-0 4-11 1/2	1860	2460	3060*	3660	4260	4860	5460	6060	7260	8460	9660
5-6 5-5 1/2	1866	2466	3066*	3666	4266	4866	5466	6066	7266	8466	9666
6-0 5-11 1/2	1872	2472	3072*	3672	4272	4872	5472	6072	7272	8472	9672
3-6 3-5 1/2	2-7 2-6 1/2 3142 SPECIAL EGRESS UNIT										

Operating Casement Sizes   
  Operating Awning Sizes

Shaded units meet most egress requirements of 5.70 sq. ft. Verify state and local requirements with your local building inspector. \*30" wide casement windows require egress hinge; customer must specify.

Grille patterns shown are standard. Other options are available.

# Next Dimension Signature

## Octagon

Rough Opp  
Frame

2-0  
1-11 1/2

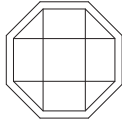

OCT 2424

2-6  
2-5 1/2

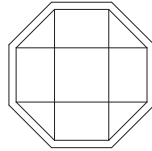

OCT 3030

3-0  
2-11 1/2

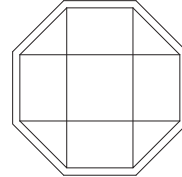

OCT 3636

2-0  
1-11 1/2

2-6  
2-5 1/2

3-0  
2-11 1/2

3-0  
2-11 1/2

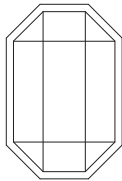

OCT 2436

3-6  
3-5 1/2

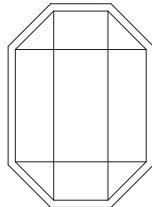

OCT 3042

4-0  
3-11 1/2

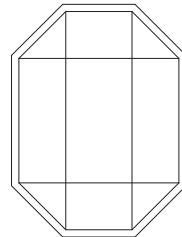

OCT 3648

Shaded units meet most egress requirements of 5.70 sq. ft. Verify state and local requirements with your local building inspector.  
Grille patterns shown are standard. Other options are available.

**All sizes and specifications subject to change without notice.**

# Next Dimension Signature

## Technical Drawings

### Casement & Awning

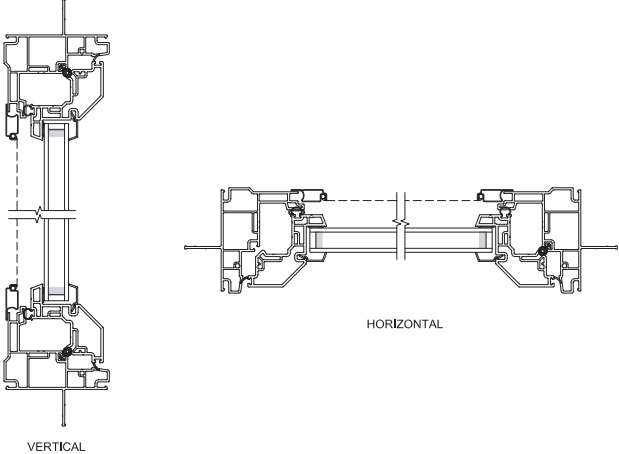

### Casement Picture

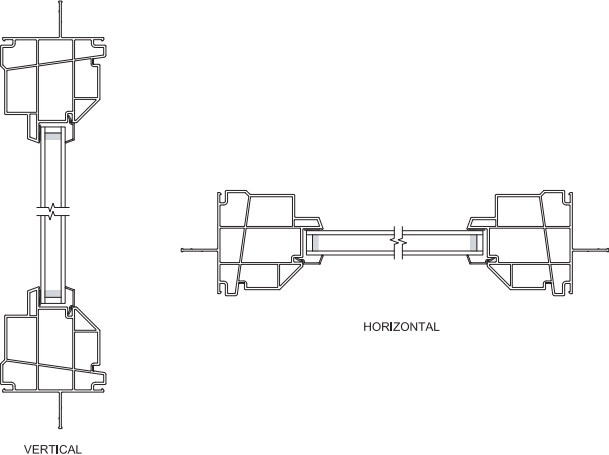

### Direct Set & Radius

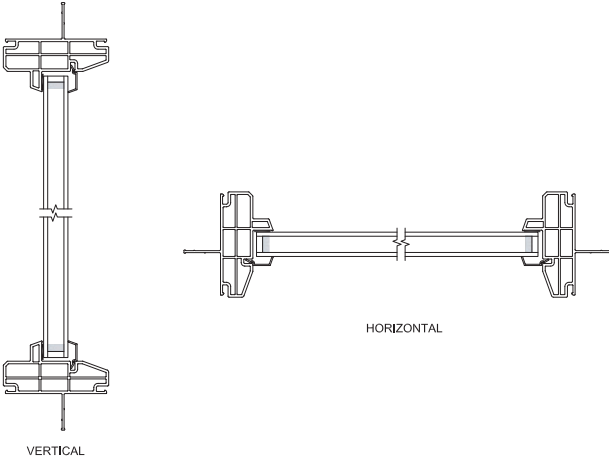

# Next Dimension Classic

## Single Hung





































































































Rough Opq Frame	1-6 1-5 1/2	2-0 1-11 1/2	2-6 2-5 1/2	2-8 2-7 1/2	3-0 2-11 1/2	3-4 3-3 1/2	3-6 3-5 1/2	4-0 3-11 1/2
2-6 2-5 1/2	1830	2430	3030	3230	3630	4030	4230	4830
3-0 2-11 1/2	1836	2436	3036	3236	3636	4036	4236	4836
3-6 3-5 1/2	1842	2442	3042	3242	3642	4042	4242	4842
4-0 3-11 1/2	1848	2448	3048	3248	3648	4048	4248	4848
4-6 4-5 1/2	1854	2454	3054	3254	3654	4054	4254	4854
5-0 4-11 1/2	1860	2460	3060	3260	3660	4060	4260	4860
5-1 5-0 1/2	1861	2461	3061	3261	3661	4061	4261	4861
5-2 5-1 1/2	1862	2462	3062	3262	3662	4062	4262	4862
5-6 5-5 1/2	1866	2466	3066	3266	3666	4066	4266	4866
6-0 5-11 1/2	1872	2472	3072	3272	3672	4072	4272	4872
6-6 6-5 1/2	1878	2478	3078	3278	3678	4078	4278	4878
7-0 6-11 1/2	1884	2484	3084	3284	3684	4084	4284	4884

Shaded units meet most egress requirements of 5.70 sq. ft. Verify state and local requirements with your local building inspector.  
Grille patterns shown are standard. Other options are available.

**All sizes and specifications subject to change without notice.**

# Next Dimension Classic

## Single Hung Fixed



















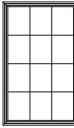



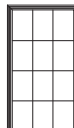

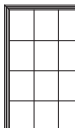
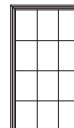
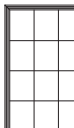
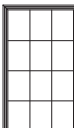



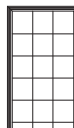



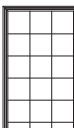

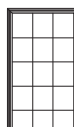

Rough Opp Frame	1-6 1-5 1/2	2-0 1-11 1/2	2-6 2-5 1/2	2-8 2-7 1/2	3-0 2-11 1/2	3-4 3-3 1/2	3-6 3-5 1/2	4-0 3-11 1/2	4-6 4-5 1/2	5-0 4-11 1/2
1-0 11 1/2	 1812	 2412	 3012	 3212	 3612	 4012	 4212	 4812	 5412	 6012
1-6 1-5 1/2	 1818	 2418	 3018	 3218	 3618	 4018	 4218	 4818	 5418	 6018
2-0 1-11 1/2	 1824	 2424	 3024	 3224	 3624	 4024	 4224	 4824	 5424	 6024
2-6 2-5 1/2	 1830	 2430	 3030	 3230	 3630	 4030	 4230	 4830	 5430	 6030
3-0 2-11 1/2	 1836	 2436	 3036	 3236	 3636	 4036	 4236	 4836	 5436	 6036
3-6 3-5 1/2	 1842	 2442	 3042	 3242	 3642	 4042	 4242	 4842	 5442	 6042
4-0 3-11 1/2	 1848	 2448	 3048	 3248	 3648	 4048	 4248	 4848	 5448	 6048
4-6 4-5 1/2	 1854	 2454	 3054	 3254	 3654	 4054	 4254	 4854	 5454	 6054
5-0 4-11 1/2	 1860	 2460	 3060	 3260	 3660	 4060	 4260	 4860	 5460	 6060
5-1 5-0 1/2	 1861	 2461	 3061	 3261	 3661	 4061	 4261	 4861	 5461	 6061

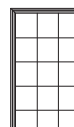
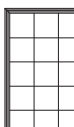
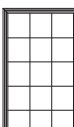
# Next Dimension Classic

## Single Hung Fixed (cont.)





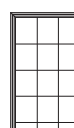
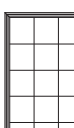
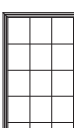











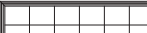

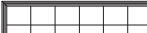







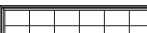
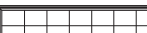
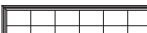
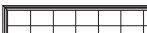















Rough Opg  
Frame

1-6    2-0    2-6    2-8    3-0    3-4    3-6    4-0    4-6    5-0  
 1-5 1/2    1-11 1/2    2-5 1/2    2-7 1/2    2-11 1/2    3-3 1/2    3-5 1/2    3-11 1/2    4-5 1/2    4-11 1/2

5-2 5-1 1/2										
	1862	2462	3062	3262	3662	4062	4262	4862	5462	6062
5-6 5-5 1/2										
	1866	2466	3066	3266	3666	4066	4266	4866	5466	6066
6-0 5-11 1/2										
	1872	2472	3072	3272	3672	4072	4272	4872	5472	6072
6-6 6-5 1/2										
	1878	2478	3078	3278	3678	4078	4278	4878	5478	6078
7-0 6-11 1/2										
	1884	2484	3084	3284	3684	4084	4284	4884	5484	6084

# Next Dimension Classic

## Single Hung Fixed (cont.)

Rough Opng Frame	6-0 5-11 1/2	6-8 6-7 1/2	7-0 6-11 1/2	7-6 7-5 1/2	8-0 7-11 1/2
1-0 1-1 1/2	 7212				
1-6 1-5 1/2	 7218	 8018	 8418	 9018	 9618
2-0 1-11 1/2	 7224	 8024	 8424	 9024	 9624
2-6 2-5 1/2	 7230	 8030	 8430	 9030	 9630
3-0 2-11 1/2	 7236	 8036	 8436	 9036	 9636
3-6 3-5 1/2	 7242	 8042	 8442	 9042	 9642
4-0 3-11 1/2	 7248	 8048	 8448	 9048	 9648
4-6 4-5 1/2	 7254	 8054	 8454	 9054	 9654
5-0 4-11 1/2	 7260	 8060	 8460	 9060	 9660
5-1 5-0 1/2	 7261	 8061	 8461	 9061	 9661



# Next Dimension Classic

## Single Hung Cottage & Oriel

### Cottage

Top sash 12" shorter than bottom sash

Rough Opq Frame	1-6	2-0	2-6	2-8	3-0	3-4	3-6	4-0
	1-5 1/2	1-11 1/2	2-5 1/2	2-7 1/2	2-11 1/2	3-3 1/2	3-5 1/2	3-11 1/2
5-0 4-11 1/2	1860	2460	3060	3260	3660	4060	4260	4860
5-1 5-0 1/2	1861	2461	3061	3261	3660e	4061	4261	4861
5-2 5-1 1/2	1862	2462	3062	3262	3662	4062	4262	4862
5-6 5-5 1/2	1866	2466	3066	3266	3666	4066	4266	4866
6-0 5-11 1/2	1872	2472	3072	3272	3672	4072	4272	4872

### Oriel

Bottom sash 12" shorter than top sash

Rough Opq Frame	1-6	2-0	2-6	2-8	3-0	3-4	3-6	4-0
	1-5 1/2	1-11 1/2	2-5 1/2	2-7 1/2	2-11 1/2	3-3 1/2	3-5 1/2	3-11 1/2
5-0 4-11 1/2	1860	2460	3060	3260	3660	4060	4260	4860
5-1 5-0 1/2	1861	2461	3061	3261	3660e	4061	4261	4861
5-2 5-1 1/2	1862	2462	3062	3262	3662	4062	4262	4862
5-6 5-5 1/2	1866	2466	3066	3266	3666	4066	4266	4866
6-0 5-11 1/2	1872	2472	3072	3272	3672	4072	4272	4872

Shaded units meet most egress requirements of 5.70 sq. ft. Verify state and local requirements with your local building inspector. Grille patterns shown are standard. Other options are available.

All sizes and specifications subject to change without notice.

# Next Dimension Classic

## Slider

Rough Opg Frame	2-0 1-11 1/2	2-6 2-5 1/2	3-0 2-11 1/2	3-6 3-5 1/2	4-0 3-11 1/2	4-6 4-5 1/2	5-0 4-11 1/2	5-6 5-5 1/2	6-0 5-11 1/2
2-0 1-11 1/2	2424	3024	3624	4224	4824	5424	6024	6624	7224
2-6 2-5 1/2	2430	3030	3630	4230	4830	5430	6030	6630	7230
3-0 2-11 1/2	2436	3036	3636	4236	4836	5436	6036	6636	7236
3-6 3-5 1/2	2442	3042	3642	4242	4842	5442	6042	6642	7242
4-0 3-11 1/2	2448	3048	3648	4248	4848	5448	6048	6648	7248
4-6 4-5 1/2			3654	4254	4854	5454	6054	6654	7254
5-0 4-11 1/2			3660	4260	4860	5460	6060	6660	7260
5-2 5-1 1/2			3662	4262	4862	5462	6062	6662	7262
5-6 5-5 1/2			3666	4266	4866	5466	6066	6666	7266
6-0 5-11 1/2			3672	4272	4872	5472	6072	6672	7272

### Handing Options

(As viewed from exterior)

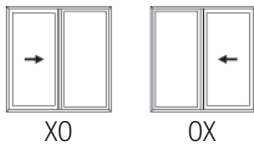

Window handing is determined while standing on the **OUTSIDE** of the window. Sliding windows must be specified as XO or OX. *X is the operable vent panel.*

Shaded units meet most egress requirements of 5.70 sq. ft. Verify state and local requirements with your local building inspector. Grille patterns shown are standard. Other options are available.

# Next Dimension Classic

## End Vent Slider

Rough Opq Frame	6-0 5-11 1/2	7-0 6-11 1/2	8-0 7-11 1/2	6-0 5-11 1/2	7-6 7-5 1/2
2-0 1-11 1/2	 18-36-1824	 21-42-2124	 24-48-2424	 24-24-2424	 30-30-3024
2-6 2-5 1/2	 18-36-1830	 21-42-2130	 24-48-2430	 24-24-2430	 30-30-3030
3-0 2-11 1/2	 18-36-1836	 21-42-2136	 24-48-2436	 24-24-2436	 30-30-3036
3-6 3-5 1/2	 18-36-1842	 21-42-2142	 24-48-2442	 24-24-2442	 30-30-3042
4-0 3-11 1/2	 18-36-1848	 21-42-2148	 24-48-2448	 24-24-2448	 30-30-3048
4-6 4-5 1/2	 18-36-1854	 21-42-2154	 24-48-2454	 24-24-2454	 30-30-3054
5-0 4-11 1/2	 18-36-1860	 21-42-2160	 24-48-2460	 24-24-2460	 30-30-3060
5-2 5-1 1/2	 18-36-1862	 21-42-2162	 24-48-2462	 24-24-2462	 30-30-3062
5-6 5-5 1/2	 18-36-1866	 21-42-2166	 24-48-2466	 24-24-2466	 30-30-3066
6-0 5-11 1/2	 18-36-1872	 21-42-2172	 24-48-2472	 24-24-2472	 30-30-3072

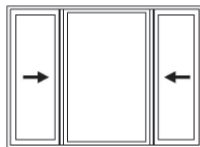

End vent sliding windows come standard as XOX. Both end vents operate.

Shaded units meet most egress requirements of 5.70 sq. ft. Verify state and local requirements with your local building inspector. Grille patterns shown are standard. Other options are available.

**All sizes and specifications subject to change without notice.**

# Next Dimension Classic

## Double Hung

Rough Opg Frame	1-6	2-0	2-6	2-8	3-0	3-4	3-6	4-0
	1-5 1/2	1-11 1/2	2-5 1/2	2-7 1/2	2-11 1/2	3-3 1/2	3-5 1/2	3-11 1/2
2-6 2-5 1/2	1830	2430	3030	3230	3630	4030	4230	4830
3-0 2-11 1/2	1836	2436	3036	3236	3636	4036	4236	4836
3-6 3-5 1/2	1842	2442	3042	3242	3642	4042	4242	4842
4-0 3-11 1/2	1848	2448	3048	3248	3648	4048	4248	4848
4-6 4-5 1/2	1854	2454	3054	3254	3654	4054	4254	4854
5-0 4-11 1/2	1860	2460	3060	3260	3660	4060	4260	4860
5-2 5-1 1/2	1862	2462	3062	3262	3662	4062	4262	4862
5-6 5-5 1/2	1866	2466	3066	3266	3666	4066	4266	4866
5-7 5-6 1/2	1867	2467	3067	3267	3667	4067	4267	4867
6-0 5-11 1/2	1872	2472	3072	3272	3672	4072	4272	4872
6-6 6-5 1/2	1878	2478	3078	3278	3678	4078	4278	4878
7-0 6-11 1/2	1884	2484	3084	3284	3684	4084	4284	4884

Shaded units meet most egress requirements of 5.70 sq. ft. Verify state and local requirements with your local building inspector.  
Grille patterns shown are standard. Other options are available.

# Next Dimension Classic

## Double Hung Fixed

Rough Opp Frame	1-6 1-5 1/2	2-0 1-11 1/2	2-6 2-5 1/2	2-8 2-7 1/2	3-0 2-11 1/2	3-4 3-3 1/2	3-6 3-5 1/2	4-0 3-11 1/2	4-6 4-5 1/2	5-0 4-11 1/2
1-0 11 1/2	1812	2412	3012	3212	3612	4012	4212	4812	5412	6012
1-6 1-5 1/2	1818	2418	3018	3218	3618	4018	4218	4818	5418	6018
2-0 1-11 1/2	1824	2424	3024	3224	3624	4024	4224	4824	5424	6024
2-6 2-5 1/2	1830	2430	3030	3230	3630	4030	4230	4830	5430	6030
3-0 2-11 1/2	1836	2436	3036	3236	3636	4036	4236	4836	5436	6036
3-6 3-5 1/2	1842	2442	3042	3242	3642	4042	4242	4842	5442	6042
4-0 3-11 1/2	1848	2448	3048	3248	3648	4048	4248	4848	5448	6048
4-6 4-5 1/2	1854	2454	3054	3254	3654	4054	4254	4854	5454	6054
5-0 4-11 1/2	1860	2460	3060	3260	3660	4060	4260	4860	5460	6060

# Next Dimension Classic

## Double Hung Fixed (cont.)













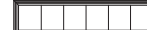











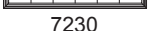

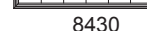

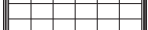
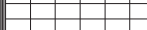
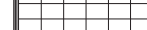

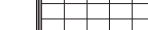





Rough Opp  
Frame

1-6    2-0    2-6    2-8    3-0    3-4    3-6    4-0    4-6    5-0  
 1-5 1/2    1-11 1/2    2-5 1/2    2-7 1/2    2-11 1/2    3-3 1/2    3-5 1/2    3-11 1/2    4-5 1/2    4-11 1/2

5-2 5-1 1/2										
	1862	2462	3062	3262	3662	4062	4262	4862	5462	6062
5-6 5-5 1/2										
	1866	2466	3066	3266	3666	4066	4266	4866	5466	6066
5-7 5-6 1/2										
	1867	2467	3067	3267	3667	4067	4267	4867	5467	6067
6-0 5-11 1/2										
	1872	2472	3072	3272	3672	4072	4272	4872	5472	6072
6-6 6-5 1/2										
	1878	2478	3078	3278	3678	4078	4278	4878	5478	6078
7-0 6-11 1/2										
	1884	2484	3084	3284	3684	4084	4284	4884	5484	6084

# Next Dimension Classic

## Double Hung Fixed (cont.)

Rough Opg Frame	6-0 5-11 1/2	6-8 6-7 1/2	7-0 6-11 1/2	7-6 7-5 1/2	8-0 7-11 1/2
1-0 1-1 1/2	 7212				
1-6 1-5 1/2	 7218	 8018	 8418	 9018	 9618
2-0 1-11 1/2	 7224	 8024	 8424	 9024	 9624
2-6 2-5 1/2	 7230	 8030	 8430	 9030	 9630
3-0 2-11 1/2	 7236	 8036	 8436	 9036	 9636
3-6 3-5 1/2	 7242	 8042	 8442	 9042	 9642
4-0 3-11 1/2	 7248	 8048	 8448	 9048	 9648
4-6 4-5 1/2	 7254	 8054	 8454	 9054	 9654
5-0 4-11 1/2	 7260	 8060	 8460	 9060	 9660

# Next Dimension Classic

## Double Hung Cottage & Oriel

### Cottage

Top sash 12"  
shorter than  
bottom sash

Rough Oppg Frame	1-6	2-0	2-6	2-8	3-0	3-4	3-6	4-0
	1-5 1/2	1-11 1/2	2-5 1/2	2-7 1/2	2-11 1/2	3-3 1/2	3-5 1/2	3-11 1/2
5-0 4-11 1/2	1860	2460	3060	3260	3660	4060	4260	4860
5-2 5-1 1/2	1862	2462	3062	3262	3662	4062	4262	4862
5-6 5-5 1/2	1866	2466	3066	3266	3666	4066	4266	4866
5-7 5-6 1/2	1867	2467	3067	3267	3676	4067	4267	4867
6-0 5-11 1/2	1872	2472	3072	3272	3672	4072	4272	4872

### Oriel

Bottom sash  
12" shorter  
than top sash

Rough Oppg Frame	1-6	2-0	2-6	2-8	3-0	3-4	3-6	4-0
	1-5 1/2	1-11 1/2	2-5 1/2	2-7 1/2	2-11 1/2	3-3 1/2	3-5 1/2	3-11 1/2
5-0 4-11 1/2	1860	2460	3060	3260	3660	4060	4260	4860
5-2 5-1 1/2	1862	2462	3062	3262	3662	4062	4262	4862
5-6 5-5 1/2	1866	2466	3066	3266	3666	4066	4266	4866
5-7 5-6 1/2	1867	2467	3067	3267	3667	4067	4267	4867
6-0 5-11 1/2	1872	2472	3072	3272	3672	4072	4272	4872

Shaded units meet most egress requirements of 5.70 sq. ft. Verify state and local requirements with your local building inspector.  
Grille patterns shown are standard. Other options are available.



# Next Dimension Classic

## Technical Drawings

### Single Hung

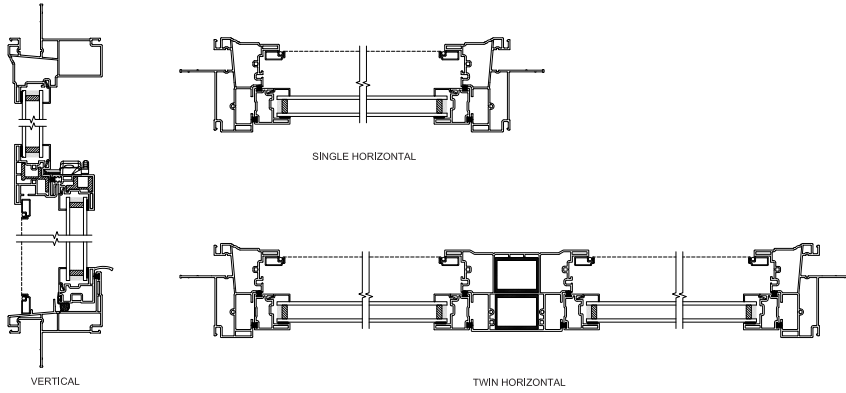

### Slider

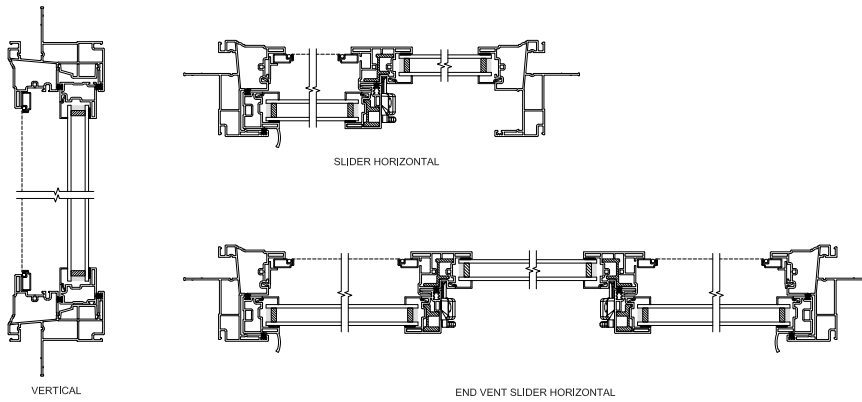

### Double Hung

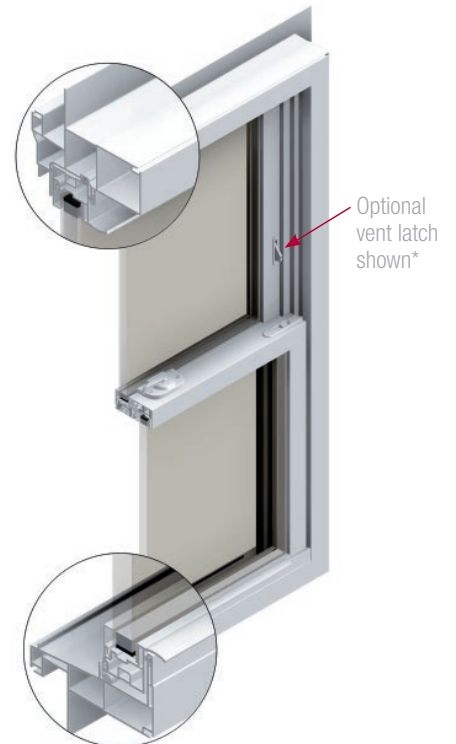
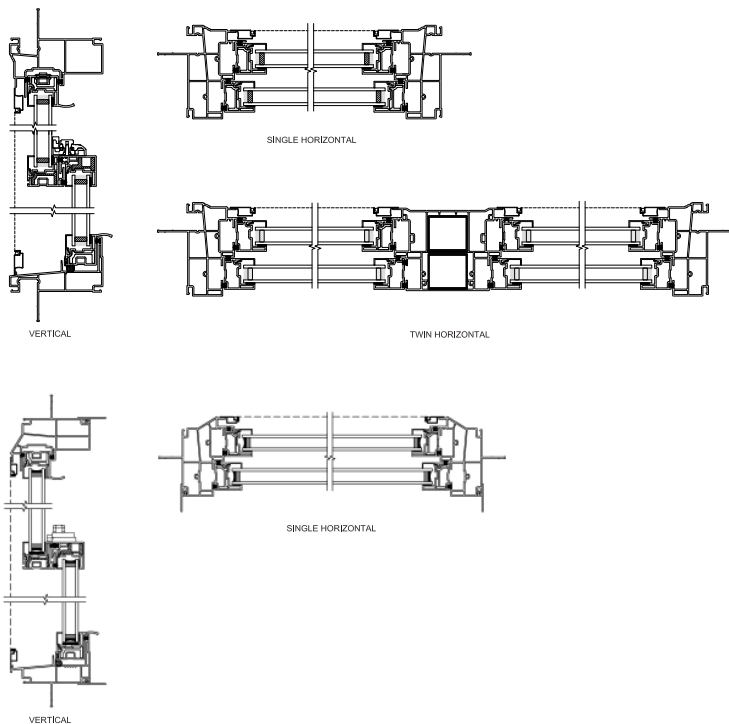

\*Vent latches shown are only available in Classic Double Hung Windows

**All sizes and specifications subject to change without notice.**

# Next Dimension Pro































































## Single Hung

Rough Opq Frame	1-6 1-5 1/2	2-0 1-11 1/2	2-6 2-5 1/2	2-8 2-7 1/2	3-0 2-11 1/2	3-6 3-5 1/2	4-0 3-11 1/2
2-0 1-11 1/2	1824	2424	3024	3224	3624	4224	4824
2-6 2-5 1/2	1830	2430	3030	3230	3630	4230	4830
3-0 2-11 1/2	1836	2436	3036	3236	3636	4236	4836
3-6 3-5 1/2	1842	2442	3042	3242	3642	4242	4842
4-0 3-11 1/2	1848	2448	3048	3248	3648	4248	4848
4-6 4-5 1/2	1854	2454	3054	3254	3654	4254	4854
5-0 4-11 1/2	1860	2460	3060	3260	3660	4260	4860
5-6 5-5 1/2	1866	2466	3066	3266	3666	4266	4866
6-0 5-11 1/2	1872	2472	3072	3272	3672	4272	4872
6-6 5-5 1/2	1878	2478	3078	3278	3678	4278	4878
7-0 6-11 1/2	1884	2484	3084	3284	3684	4284	

Shaded units meet most egress requirements of 5.70 sq. ft. Verify state and local requirements with your local building inspector.  
Grille patterns shown are standard. Other options are available.



















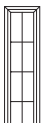





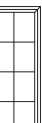

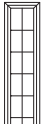











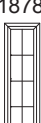

# Next Dimension Pro

## Fixed

	1-6 1-5 1/2	2-0 1-11 1/2	2-6 2-5 1/2	3-0 2-11 1/2	3-6 3-5 1/2	4-0 3-11 1/2	5-0 4-11 1/2	6-0 5-11 1/2	7-0 6-11 1/2
1-0 11 1/2	 1812	 2412	 3012	 3612	 4212	 4812	 6012	 7212	 8412
1-6 1-5 1/2	 1818	 2418	 3018	 3618	 4218	 4818	 6018	 7218	 8418
2-0 1-11 1/2	 1824	 2424	 3024	 3624	 4224	 4824	 6024	 7224	 8424
3-0 2-11 1/2	 1836	 2436	 3036	 3636	 4236	 4836	 6036	 7236	 8436
3-6 3-5 1/2	 1842	 2442	 3042	 3642	 4242	 4842	 6042	 7242	 8442
4-0 3-11 1/2	 1848	 2448	 3048	 3648	 4248	 4848	 6048	 7248	 8448
4-6 4-5 1/2	 1854	 2454	 3054	 3654	 4254	 4854	 6054	 7254	 8454

# Next Dimension Pro

## Fixed (cont.)

	1-6 1-5 1/2	2-0 1-11 1/2	2-6 2-5 1/2	3-0 2-11 1/2	3-6 3-5 1/2	4-0 3-11 1/2	5-0 4-11 1/2	6-0 5-11 1/2	7-0 6-11 1/2
5-0 4-11 1/2	 1860	 2460	 3060	 3660	 4260	 4860	 6060	 7260	 8460
5-6 5-5 1/2	 1866	 2466	 3066	 3666	 4266	 4866	 6066	 7266	 8466
6-0 5-11 1/2	 1872	 2472	 3072	 3672	 4272	 4872	 6072	 7272	 8472
6-6 6-5 1/2	 1878	 2478	 3078	 3678	 4278	 4878	 6078	 7278	
7-0 6-11 1/2	 1884	 2484	 3084	 3684	 4284	 4884	 6084	 7284	

# Next Dimension Pro

## Single Hung Cottage & Oriel

### Cottage

Top sash 12" shorter than bottom sash

Rough Opn Frame	1-6	2-0	2-6	2-8	3-0	3-6	4-0
	1-5 1/2	1-11 1/2	2-5 1/2	2-7 1/2	2-11 1/2	3-5 1/2	3-11 1/2
5-0 4-11 1/2							
	1860	2460	3060	3260	3660	4260	4860
5-6 5-5 1/2							
	1866	2466	3066	3266	3666	4266	4866
6-0 5-11 1/2							
	1872	2472	3072	3272	3672	4272	4872

### Oriel

Bottom sash 12" shorter than top sash

Rough Opn Frame	1-6	2-0	2-6	2-8	3-0	3-6	4-0
	1-5 1/2	1-11 1/2	2-5 1/2	2-7 1/2	2-11 1/2	3-5 1/2	3-11 1/2
5-0 4-11 1/2							
	1860	2460	3060	3260	3660	4260	4860
5-6 5-5 1/2							
	1866	2466	3066	3266	3666	4266	4866
6-0 5-11 1/2							
	1872	2472	3072	3272	3672	4272	4872
6-6 5-5 1/2							
	1878	2478	3078	3278	3678	4278	4878
7-0 6-11 1/2							
	1884	2484	3084	3284	3684	4284	

Shaded units meet most egress requirements of 5.70 sq. ft. Verify state and local requirements with your local building inspector. Grille patterns shown are standard. Other options are available.

All sizes and specifications subject to change without notice.

# Next Dimension Pro

## Single Hung Radius & Oriel

### Radius

Rough Opp Frame	2-6	2-6	3-0	3-4	3-6	4-0
	2-5 1/2	2-5 1/2	2-11 1/2	3-3 1/2	3-5 1/2	3-11 1/2
3-0 2-11 1/2	3036	3236	3636	4036	4236	4836
3-6 3-5 1/2	3042	3242	3642	4042	4242	4842
4-0 3-11 1/2	3048	3248	3648	4048	4248	4848
4-6 4-5 1/2	3054	3254	3654	4054	4254	4854
5-0 4-11 1/2	3060	3260	3660	4060	4260	4860
5-6 5-5 1/2	3066	3266	3666	4066	4266	4866
6-0 5-11 1/2	3072	3272	3672	4072	4272	4872

### Oriel

Bottom sash  
12" shorter  
than top sash

Rough Opp Frame	2-6	2-6	3-0	3-4	3-6	4-0
	2-5 1/2	2-5 1/2	2-11 1/2	3-3 1/2	3-5 1/2	3-11 1/2
5-0 4-11 1/2	3060	3260	3660	4060	4260	4860
5-6 5-5 1/2	3066	3266	3666	4066	4266	4866
6-0 5-11 1/2	3072	3272	3672	4072	4272	4872

Shaded units meet most egress requirements of 5.70 sq. ft. Verify state and local requirements with your local building inspector.  
Grille patterns shown are standard. Other options are available.

# Next Dimension Pro

## Slider

	2-0 1-11 1/2	2-6 2-5 1/2	3-0 2-11 1/2	3-6 3-5 1/2	4-0 3-11 1/2	4-6 4-5 1/2	5-0 4-11 1/2	5-6 5-5 1/2	6-0 5-11 1/2
2-0 1-11 1/2	2424	3024	3624	4224	4824	5424	6024	6624	7224
2-6 2-5 1/2	2430	3030	3630	4230	4830	5430	6030	6630	7230
3-0 2-11 1/2	2436	3036	3636	4236	4836	5436	6036	6636	7236
3-6 1-11 1/2	2442	3042	3642	4242	4842	5442	6042	6642	7242
4-0 3-11 1/2	2448	3048	3648	4248	4848	5448	6048	6648	7248
4-6 4-5 1/2			3654	4254	4854	5454	6054	6654	7254
5-0 4-11 1/2			3660	4260	4860	5460	6060	6660	7260
5-6 5-5 1/2			3666	4266	4866	5466	6066	6666	7266

### Other Grille Patterns

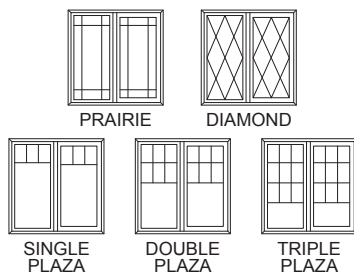

### Handing Options

(As viewed from exterior)

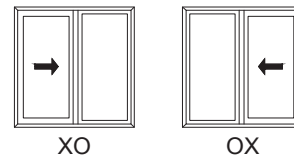

Window handing is determined while standing on the **OUTSIDE** of the window. Sliding windows must be specified as XO or OX. *X is the operable vent panel.*

Shaded units meet most egress requirements of 5.70 sq. ft. Verify state and local requirements with your local building inspector.  
Grille patterns shown are standard. Other options are available.

**All sizes and specifications subject to change without notice.**

# Next Dimension Pro

## Offset Slider

Rough Opp. Frame	5-6	6-0	6-6
	5-5 1/2	5-11 1/2	6-5 1/2
2-0 1-11 1/2	6624	7224	7824
2-6 2-5 1/2	6630	7230	7830
3-0 2-11 1/2	6636	7236	7836
3-6 3-5 1/2	6642	7242	7842
4-0 3-11 1/2	6648	7248	7848
4-6 4-5 1/2	6654	7254	7854
5-0 4-11 1/2	6660	7260	7860
5-6 5-5 1/2	6666	7266	7866

### Other Grille Patterns

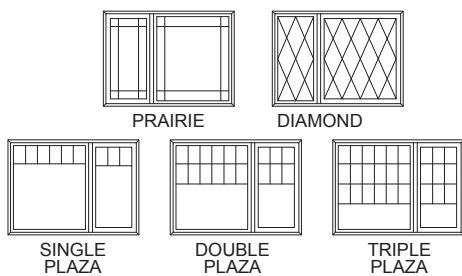

### Handing Options

(As viewed from exterior)

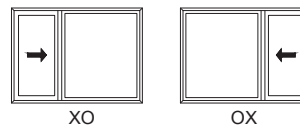

Window handing is determined while standing on the **OUTSIDE** of the window. Sliding windows must be specified as XO or OX. *X is the operable vent panel.*

Shaded units meet most egress requirements of 5.70 sq. ft. Verify state and local requirements with your local building inspector.  
Grille patterns shown are standard. Other options are available.



# Next Dimension Pro

## End Vent Slider

Rough Oppg. Frame	6-0	6-0	7-0	7-6	8-0
	5-11 1/2	5-11 1/2	6-11 1/2	7-5 1/2	7-11 1/2
2-0 1-11 1/2	 18-36-1824	 24-24-2424	 21-42-2124	 30-30-3024	 24-48-2424
2-6 2-5 1/2	 18-36-1830	 24-24-2430	 21-42-2130	 30-30-3030	 24-48-2430
3-0 2-11 1/2	 18-36-1836	 24-24-2436	 21-42-2136	 30-30-3036	 24-48-2436
3-6 3-5 1/2	 18-36-1842	 24-24-2442	 21-42-2142	 30-30-3042	 24-48-2442
4-0 3-11 1/2	 18-36-1848	 24-24-2448	 21-42-2148	 30-30-3048	 24-48-2448
4-6 4-5 1/2	 18-36-1854	 24-24-2454	 21-42-2154	 30-30-3054	 24-48-2454
5-0 4-11 1/2	 18-36-1860	 24-24-2460	 21-42-2160	 30-30-3060	 24-48-2460
5-6 5-5 1/2	 18-36-1866	 24-24-2466	 21-42-2166	 30-30-3066	 24-48-2466

### Other Grille Patterns

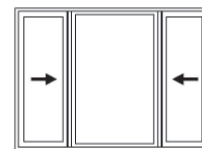
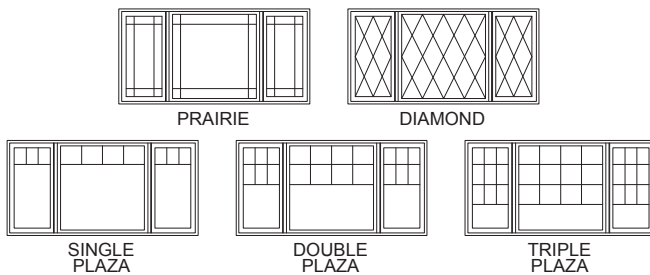

End vent sliding windows come standard as XOX. Both end vents operate.

Shaded units meet most egress requirements of 5.70 sq. ft. Verify state and local requirements with your local building inspector. Grille patterns shown are standard. Other options are available.

All sizes and specifications subject to change without notice.

# Next Dimension Pro

## Technical Drawings

### Single Hung

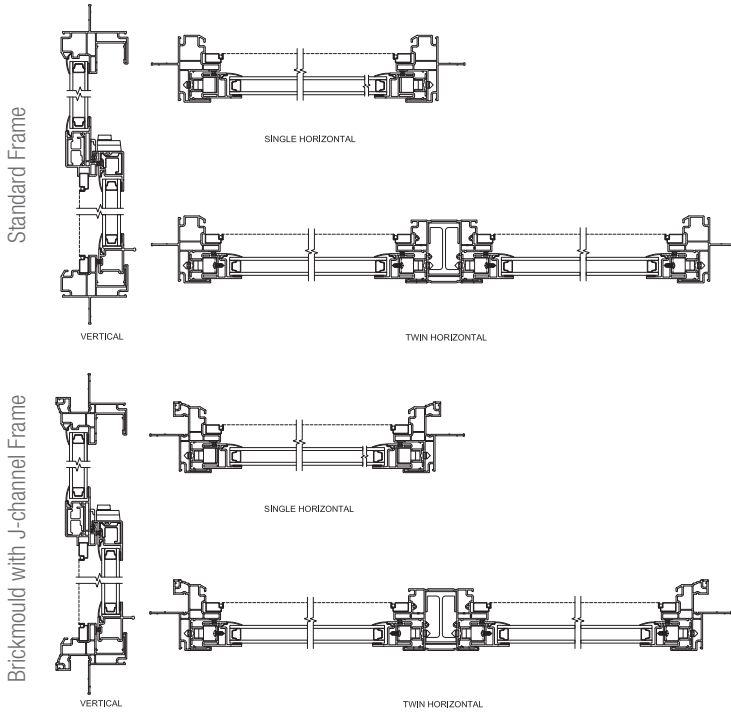

### Slider

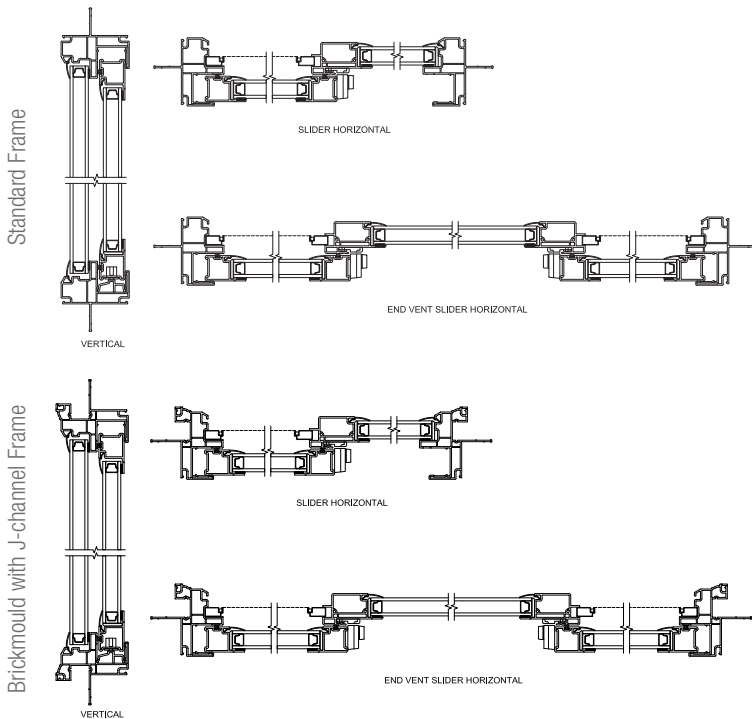

### Picture, Direct Set & Radius

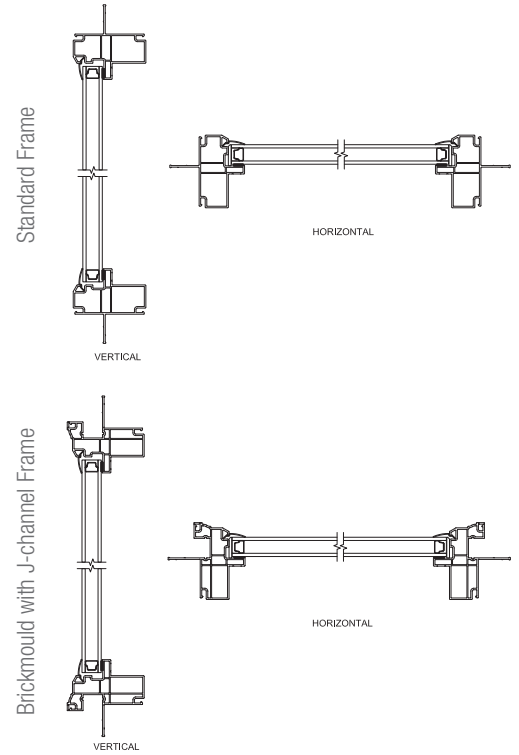

# Next Dimension

## Sliding Patio Doors

Rough Opng Frame	5-0 4-11 1/2	6-0 5-11 1/2	7-6 7-5 1/2	8-0 7-11 1/2	9-0 8-11 1/2
6-8 6-7 1/2	5068-XO	6068-OX	7668-OXS	8068-XO	9068-OXS
6-10 6-9 1/2	50610-XO	60610-OX	76610-OXS	80610-XO	90610-OXS
8-0 7-11 1/2	5080-XO	6080-OX	7680-OXS	8080-XO	9080-OXS

Door handing is determined while standing on the **OUTSIDE** of the door. "X" is the operating panel and "O" is the stationary panel.

**XO door:** Operating panel is on the left.

**OX door:** Operating panel is on the right.

This door handing can be switched prior to installation. An additional sill threshold cover, in the opposite handing, must be purchased from your local Windsor Windows & Doors distributor in order to complete the handing change. This option cannot be done on 8-0 doors.

Two-panel sliding patio doors must be specified as XO or OX. Three-panel sliding patio doors must be specified as XOO, OXO or OOX.

*X is the operable vent panel.*

### Sliding Patio Door Technical Drawings

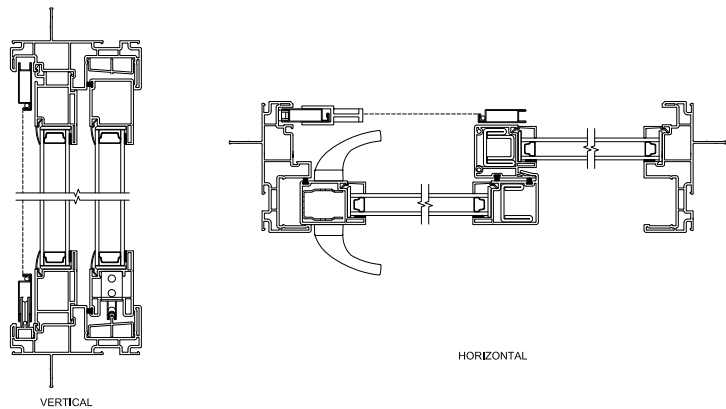

Grille patterns shown are standard. Other options are available.

**All sizes and specifications subject to change without notice.**

# Next Dimension

## Quad Sliding Patio Doors

Mas. Opg.  
Rough Opg.  
Frame  
Glass

9-9 15/16  
9-9 15/16  
9-9 7/16  
2-3 3/32

11-9 15/16  
11-9 15/16  
11-9 7/16  
2-9 3/32

6-8  
6-8  
6-7 1/2  
6-1 3/8

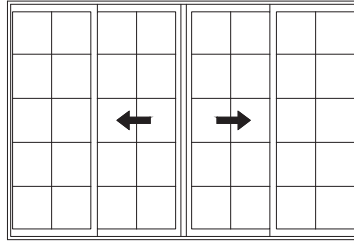

10068-OXOO

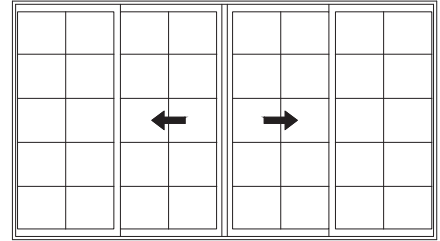

12068-OXOO

6-10  
6-10  
6-9 1/2  
6-3 3/8

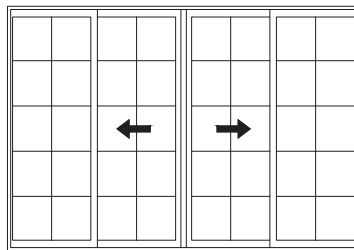

100610-OXOO

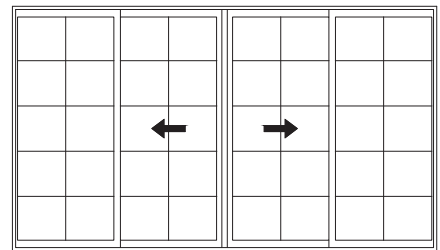

120610-OXOO

8-0  
8-0  
7-11 1/2  
7-5 3/8

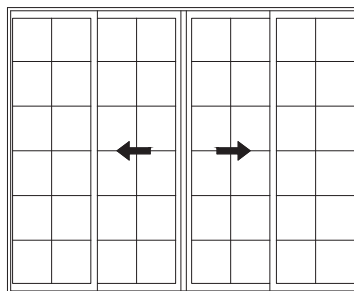

10080-OXOO

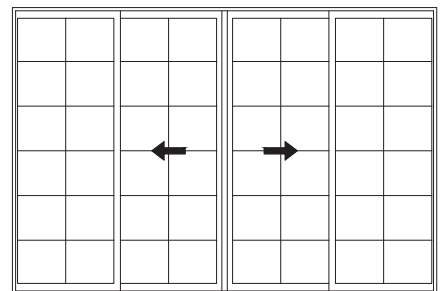

12080-OXOO

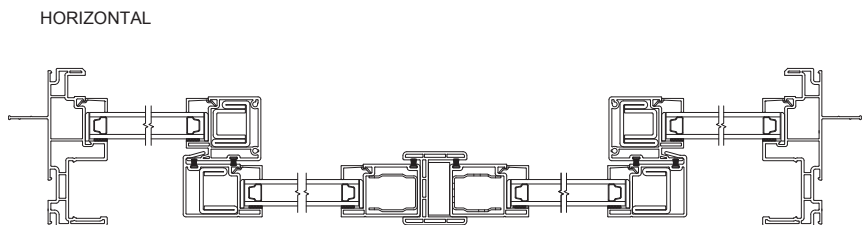
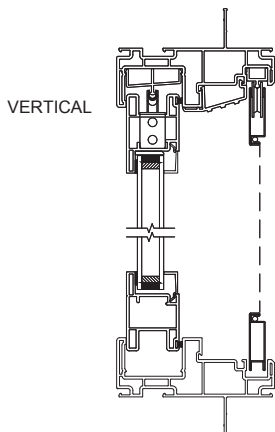







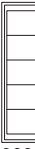

Grille patterns shown are standard. Other options are available.

All sizes and specifications subject to change without notice.

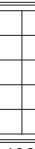

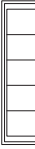

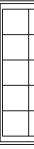
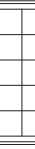

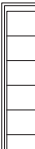
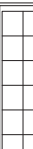
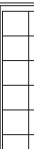
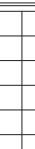

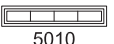
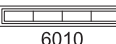

## Next Dimension

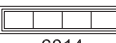
# Patio Door Sidelites, Transoms & Sidelite Transoms

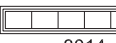





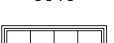
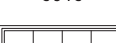
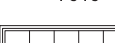
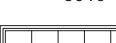
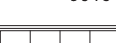













### Sidelites

	1-6 1-5 1/2	2-0 1-11 1/2	2-6 2-5 1/2	3-0 2-11 1/2	4-0 3-11 1/2
Rough Opg Frame					
6-8 6-7 1/2					
	1668-S	2068-S	2668-S	3068-S	4068-S
6-10 6-9 1/2					
	16610-S	20610-S	26610-S	30610-S	40610-S
8-0 7-11 1/2					
	1680-S	2080-S	2680-S	3080-S	4080-S

### Transoms

	5-0 4-11 1/2	6-0 5-11 1/2	7-6 7-5 1/2	8-0 7-11 1/2	9-0 8-11 1/2
Rough Opg Frame					
1-0 11 1/2					
	5010	6010			
1-4 1-3 1/2					
	5014	6014	7614	8014	9014
1-6 1-5 1/2					
	5016	6016	7616	8016	9016
2-0 1-11 1/2					
	5020	6020	7620	8020	9020

### Sidelite Transoms

	1-6 1-5 1/2	2-0 1-11 1/2	2-6 2-5 1/2	3-0 2-11 1/2	4-0 3-11 1/2
Rough Opg Frame					
1-0 11 1/2					
	1610	2010	2610	3010	4010
1-4 1-3 1/2					
	1614	2014	2614	3014	4014
1-6 1-5 1/2					
	1616	2016	2616	3016	4016
2-0 1-11 1/2					
	1620	2020	2620	3020	4020

Grille patterns shown are standard. Other options are available.

All sizes and specifications subject to change without notice.



**Windsor Windows & Doors has distinct product lines for every application.** New construction. Room additions. Window replacement. Windsor has the solutions to help meet any home building or home improvement need. Discover all of the products we have to offer.

# Make every project a success.



## Pinnacle

The strength and beauty of natural wood define our elite Pinnacle line of products. Crafted from the finest pine, alder and fir, Pinnacle windows and doors add a measure of elegance to any home.

From subtle to showy, Pinnacle products are endlessly customizable through an array of finishes, hardware, shapes, grille options, cladding colors, glass and trim options, allowing the perfect window or door to be created.

Homeowners can choose from the technologically advanced Pinnacle Select, the durable and damage resistant Pinnacle wood clad or Pinnacle primed, which arrives ready to be painted.

## Legend

Legend products are constructed from solid cellular PVC, creating the traditional look and feel of painted wood with the low maintenance and strong durability of vinyl. Our windows are protected against rotting, warping, cracking or swelling with a 25-year warranty. Legend products are well suited for both new construction and historical renovation.

Legend HBR products combine the strength and durability of our Legend cellular PVC frame with a wood clad sash. This powerful hybrid offers a low-maintenance exterior with a beautiful wooden interior.

## Next Dimension

Next Dimension Signature windows and doors are robust, reliable products that offer the resilience of extruded multi-chambered vinyl. Enhanced components and sturdy construction add strength and stability. Homeowners enjoy exceptional performance and energy efficiency.

Next Dimension Classic is available in single and double hung units, sliders and sliding patio doors. What makes Next Dimension Classic unique is its sloped sill, tilt sash, brickmould profile frame and decorative features, such as a profiled inner grille and simulated divided lite.

Next Dimension Pro vinyl windows and patio doors are designed for light commercial, multi-family and residential applications, all at a highly competitive price. Vinyl extrusions ensure superior weathering, durability and color retention. Construction features are built in to reduce maintenance, add strength and security, and maximize weather resistance.

All Next Dimension vinyl products are available in white or clay, as well as seven exterior colors (white, ivory, tan, bronze, cinnamon, hunter green and black). Our vinyl windows are highly rated for performance and many even offer commercially rated performance. All of our vinyl products are low maintenance and are backed by a lifetime limited warranty.

## Revive™ Pocket Replacement Windows

There's a lot to love about a home – its unique character, timeless details and genuine craftsmanship. Drafty, unsightly windows can easily steal away from the beauty of these features. That's where Revive pocket replacement windows come into the picture.

Each window can be transformed with stunning Windsor quality in about an hour – with fewer worries about disturbing any treasured wood trim or other interior and exterior features. And because they're meticulously built to order with customizable features in three high-quality materials (wood clad, hybrid and vinyl), Windsor Revive pocket replacement windows are a fast, uncomplicated upgrade.

## Revive Sash Replacement Kit

Replace old, drafty, inefficient double hung sashes with energy efficient, dual pane sashes. Windsor's Revive Sash Replacement Kit makes updating easy, allowing homeowners to leave existing interior trim and plaster in place. Choose from three different replacement sashes: versatile primed wood, durable aluminum clad or low-maintenance cellular PVC. Revive sashes feature EZ Tilt, which provides fast access for hassle-free cleaning.

For more information on all of our products, visit us at [www.windsorwindows.com](http://www.windsorwindows.com).



CONNECT WITH US



900 South 19th Street, West Des Moines, IA 50265 • 515.223.6660 • 800.218.6186  
2210 Stafford Street Extension, Monroe, NC 28110 • 704.283.7459 • 800.205.5665

[www.windsorwindows.com](http://www.windsorwindows.com)

A WOODGRAIN COMPANY

© 2023 Woodgrain Millwork Inc. Woodgrain Millwork, Windsor, the Windsor Lion logo, Next Dimension and Legend are registered trademarks of Woodgrain Millwork Inc. Windsor Windows & Doors, Pinnacle, Revive and Redstone are trademarks of Woodgrain Millwork Inc.



*Windsor Windows & Doors is an ENERGY STAR® partner and an NFRC and WDMA member. Windsor products are certified and labeled according to the guidelines established by the National Fenestration Rating Council (NFRC).*